

Centre for Archaeological Fieldwork
School of Archaeology and Palaeoecology
Queen's University Belfast



Data Structure Report: No. 5.

**Investigations at Ballyarnet (Occupation Site), Co.
Londonderry**
AE/02/71

On behalf of



Data Structure Report: Ballyarnet, County Londonderry

John Ó Néill, Dr. Rick Schulting, Dr. Nicki Whitehouse, Keith Adams and Thom Kerr.

(Grid Reference J54745384)

(CAF DSR 005)

(Licence No. AE/02/71)

(SMR No. LDY 14A:026)

Contents	Page
List of Figures	2
List of Plates	2
Summary	3
Introduction	5
<i>General</i>	
<i>Background</i>	
<i>Reason for Excavation and Research Objectives</i>	
<i>Archiving</i>	
<i>Credits and Acknowledgements</i>	
Topographic Survey	14
<i>Methodology</i>	
<i>Results of the Topographic Survey</i>	
Environmental Sampling	15
<i>Introduction</i>	
<i>Sampling Strategy</i>	
<i>Insect Sampling</i>	
<i>Burnt Mound LDY14A:025</i>	
Excavation	18
<i>Methodology</i>	
<i>Account of the excavations</i>	
<i>Northern section face of the drain</i>	
<i>Southern section face of the drain</i>	
<i>Trench 1</i>	
<i>Trench 2</i>	
<i>Trench 3</i>	
<i>Trench 4</i>	
<i>Phasing of the stratigraphic sequences</i>	
<i>Artefactual Dating</i>	
Results and Discussion	31
<i>Results</i>	
<i>Discussion</i>	
Recommendations for further work	35
<i>Introduction</i>	
<i>Programme of post-excavation analysis</i>	
<i>Analysis of the Environmental Samples</i>	
<i>Further Excavation</i>	
Bibliography	38
Appendix One: Context List	40
Appendix Two: Harris Matrices	42
Appendix Three: Photographic Record	44
Appendix Four: Field Drawing Register	47
Appendix Five: Small Finds Register	48
Appendix Six: Sample Register	51

List of Figures:

	Page
Figure 1. General location map	8
Figure 2: Ordnance Survey: County Londonderry, Sheet 14A, 6 inch series, 1936 (not reproduced to scale). Extent of Lake is that depicted on the 1 st edition map (1830), with the convention for marsh indicating the extent of encroachment by 1936.	9
Figure 3. Map showing the location of excavation, pollen cores and nearby sites.	10
Figure 4. Contour map of the area of the excavation, mound and burnt mound.	11
Figure 5. Contour map of mound.	12
Figure 6. Plan showing the mound and the location of the excavation trenches.	13
Figure 7. Plan of excavated features.	24
Figure 8. Section of drain (northern side).	25
Figure 9. Section of drain (southern side).	26
Figure 10. Available dates for Cordoned Urns.	33

List of Plates

Plate 1. Aerial photograph: V(SVY)S058(D) 16AUG02 02/3974.	27
Plate 2. Photo of mound.	28
Plate 3. Photo of drain-face (across Phase 1 furnace).	28
Plate 4. Arrowhead.	29
Plate 5. Photo of axed post.	29
Plate 6. Photo of furnace.	30
Plate 7. Photo of Cordoned Urn sherds.	30

1. Summary

- 1.1 The site of the Ballyarnet investigations lies on the edge of Ballyarnet Lake, 4 km to the north-west of Derry City. The area where the excavations took place lay on the margin of the existing fens around the lake, where a drainage ditch had exposed some archaeological materials, recorded in the SMR as LDY14A:026. The ground to the north-west of the site sloped up to Racecourse Road, 200 m away and some 6 m above the level of the archaeological deposits.
- 1.2 The archaeological deposits exposed in the drainage ditch had previously produced struck flint and sherds of Bronze Age pottery. Prior to the excavation, some worked timbers and re-deposited clays were visible in section, suggesting that some form of occupation had occurred at the site. A small mound lies 15 m to the north-west of the exposed archaeological deposit (and is recorded under the same SMR designation), and a burnt mound, recorded as LDY14A:025, lies at the top of the slope beside Racecourse Road.
- 1.3 Topographic survey, environmental sampling and limited excavation were undertaken at the site in July and August 2002 with the aims of ascertaining the character of the site, procuring samples that would provide information regarding the early prehistoric environment of the area and assessing the on-going risk to the waterlogged deposits. Four trenches were opened across the archaeological deposits. Two cores and a monolith were also taken through peat deposits around the lake edge. A sample of charcoal was also collected from the eroding section of the burnt mound to the north-west of the excavated area.
- 1.4 The sherds of Bronze Age pottery have now been recognised as Cordoned Urn, and sherds of other Cordoned Urn vessels were recovered during the excavations, along with a tanged arrowhead, which may be of Causeway Basalt. Other artefacts recovered during the excavation include coarse ware sherds, lithics and possible metalworking debris. The sections of the archaeological deposits, exposed in the drainage ditch, were recorded and a basic stratigraphic sequence created for the site. On this basis, it is suggested that the initial construction of a palisaded timber platform was followed by four phases of activity, after which the site may have been inundated.
- 1.5 The survey and excavation at the site had identified that there is a considerable threat of degradation of the archaeological materials due to the ongoing drainage at the site. Any future management strategies for the site should take this factor into consideration.
- 1.6 An aerial photograph, taken following the completion of the excavation in August 2002, has revealed a further site, visible as a cropmark in a field some 200 m to the south-west. At this

site an oval cropmark, measuring 60 m by 40 m, encloses a series of circular anomalies. Another recorded mound, LDY14A:021, lies between the enclosure and the margins of fen.

- 1.7 The evidence to date suggests that a waterlogged occupation site, of some significance and datable by the presence of Cordoned Urn sherds, is present at SMR LDY14A:026. The relationship between the recorded archaeological deposits and the mound was not examined in the course of the excavations, but geodetic survey of the mound suggests it was originally circular and is likely to represent an activity distinct from the occupation site.
- 1.8 The excavations, environmental sampling, topographic survey and recent aerial photograph, have identified the archaeological and palaeoecological importance of the landscape around Ballyarnet Lake. It is recommended that an initial programme of post-excavation, environmental analysis and a second season of excavations at the site are conducted in order to resolve further issues regarding the nature of the occupation site. Following completion of the proposed excavations, a revised data structure report will be produced outlining the post-excavation programme and resources required to meaningfully publish both seasons of excavation and bring the project to completion.

2. Introduction

2.1 General

2.1.1 The following report details the preliminary results of the topographic survey, palaeoenvironmental sampling and archaeological excavation at Ballyarnet, undertaken by the Centre for Archaeological Fieldwork, School of Archaeology and Palaeoecology at Queen's University Belfast in July and August 2002. This programme of work was undertaken on behalf of the Environment and Heritage Service, DOE NI, who funded the survey and excavations.

2.2 Background

2.2.1 Ballyarnet Lake lies 4 – 5 km to the north-west of Derry City, around 1.5 km from the shores of Lough Foyle (see Figure 1). Now surrounded by farmlands, a golf course and residential developments, the lake and its surrounding fens have been retained by the local council as a public park. The fenlands around the lake include some stands of willow, alder and hazel and substantial reed lawns largely obscuring the remaining area of open water in the centre of the lake basin. The fens are fringed by meadows, with the land rising quite steeply away from the basin to the north and south. Maps of the area indicate streams feeding into the lake from the south-west and exiting to the north east, although the modern developed landscape prevented identification of the streams. A series of drainage channels have been opened through the fen peats around the lake (these are visible in Plate 1). The extent of the surface water of the lake has shrank since that indicated by the first edition OS map (see Figure 2), due to the recent drainage.

2.2.2 The site was first reported to EHS by Mr. Ian Leitch, a local amateur archaeologist and member of the Templemore Archaeological Field-Walkers Society. He had noted that deposits of peat, excavated as part of a drainage operation by the local council, contained quantities of clay, stone, burnt stone, charcoal and worked wood. At least one stone feature was noted on the ground surface, several metres from the drainage ditch. Closer examination produced a number of artefacts, and the site was duly referred to Environment and Heritage Service. A subsequent inspection by Environment and Heritage Service staff confirmed the initial findings and the site was entered on the Sites and Monuments Record as LDY14A:026.

2.2.3 A number of other archaeological sites have been discovered on the fringes of the lake (indicated on Figure 3). These include a possible Neolithic trackway (SMR reference LDY14A:020), three burnt mounds (SMR references LDY14A:031; LDY14A:025; LDY14A:028) and two unclassified mounds (SMR references LDY14A:021 and LDY14A:026).

2.2.4 An aerial photograph, taken in August 2002 and made available for analysis in November 2002, indicates the presence of a substantial oval enclosure, adjacent to the unclassified mound LDY14A:021, some 200 m south-west of the site of the excavations. This enclosure contains several circular features, ranging in size from c. 10 m to 30 m. This complex of features has not been previously noted.

2.3 *Reason for Excavation and Research Objectives*

2.3.1 The potential of the SMR site LDY14A:026 was noted during a general survey of the area, undertaken in 2002, for suitable sites for a programme of palaeoecological sampling aimed at establishing the environmental background to the Neolithic occupation site at Thornhill (Logue 2000). Preliminary coring suggested that peat-forming sequences of substantial length were present beneath the fens around Ballyarnet Lake. On this basis, the Environment and Heritage Service, DOE NI, consented to some investigation of the archaeological deposits at LDY14A:026 to establish a context for the sampling programme.

2.3.2 As limited excavation was to take place, a number of objectives were decided upon, addressing several issues relevant to the site. The main objective of the excavation was to establish the nature and date of the structure present at the site, and, by doing so, to assess the threat posed by the ongoing drainage of the fens around Ballyarnet Lake. To inform future management and protection strategies for the site, a geodetic survey was undertaken to provide a base map of the archaeological features, such as the burnt mound, occupation site and mound. In archaeological terms, and despite the limited nature of the excavation, some questions regarding wider parallels for the structure could be addressed. The palaeoecological sampling programme, for which the excavation was initially undertaken, would not only address the environmental context of the occupation of both Thornhill and the Ballyarnet Lake site, but could potentially shed light on the impetus for construction at the site. This is perhaps the most significant archaeological question which could be asked during the 2002 investigations: was the site occupied, opportunistically, when lake levels were low, or was it deliberately located in a fen for other reasons?

2.4 *Archiving*

2.4.1 A copy of this report has been deposited with the Environment and Heritage Service, DOE NI. All site records and finds are temporarily archived within the School of Archaeology and Palaeoecology, Queen's University Belfast. Site records, including context sheets, plans and photographic archive, small finds and samples, as retained by the School of Archaeology and Palaeoecology, are listed in the Appendices at the end of this report.

2.5 *Credits and Acknowledgements*

2.5.1 The excavations were directed by John Ó Néill and Rick Schulting and supervised by Ruth Logue, assisted by Thom Kerr. The excavation team consisted of the School of Archaeology and Palaeoecology students undertaking the taught excavations module in 2002. The topographic survey of the site was undertaken by Keith Adams assisted by members of the excavation team. Access to the site was permitted by Derry City Council, and facilitated by the local residents, particularly Mr. Pat Quigley.

2.5.2 The illustrations and images included in this report were produced by Keith Adams, Bronagh Murray, John Ó Néill and Rick Schulting. The aerial photograph (Plate 1) was acquired from the R.A.F. archives for Northern Ireland.

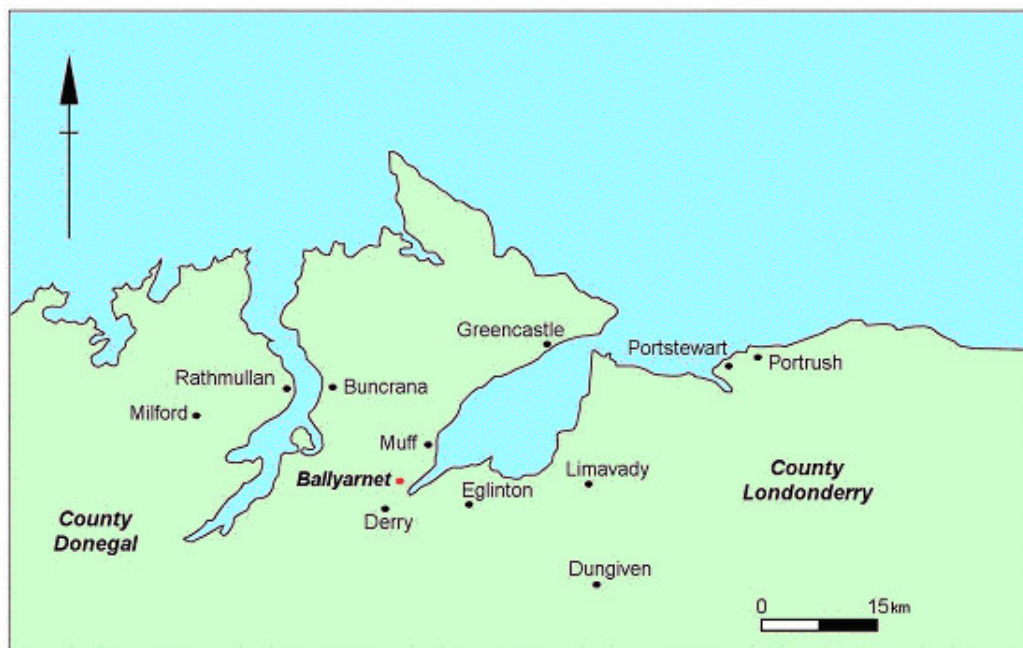

Figure 1. General location map.

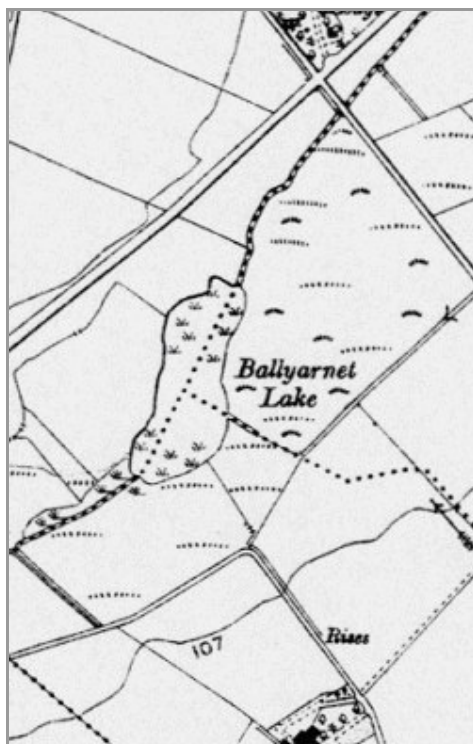

Figure 2: Ordnance Survey: County Londonderry, Sheet 14A, 6 inch series, 1936 (not reproduced to scale). Extent of Lake is that depicted on the 1st edition map (1830), with the convention for marsh indicating the extent of encroachment by 1936.

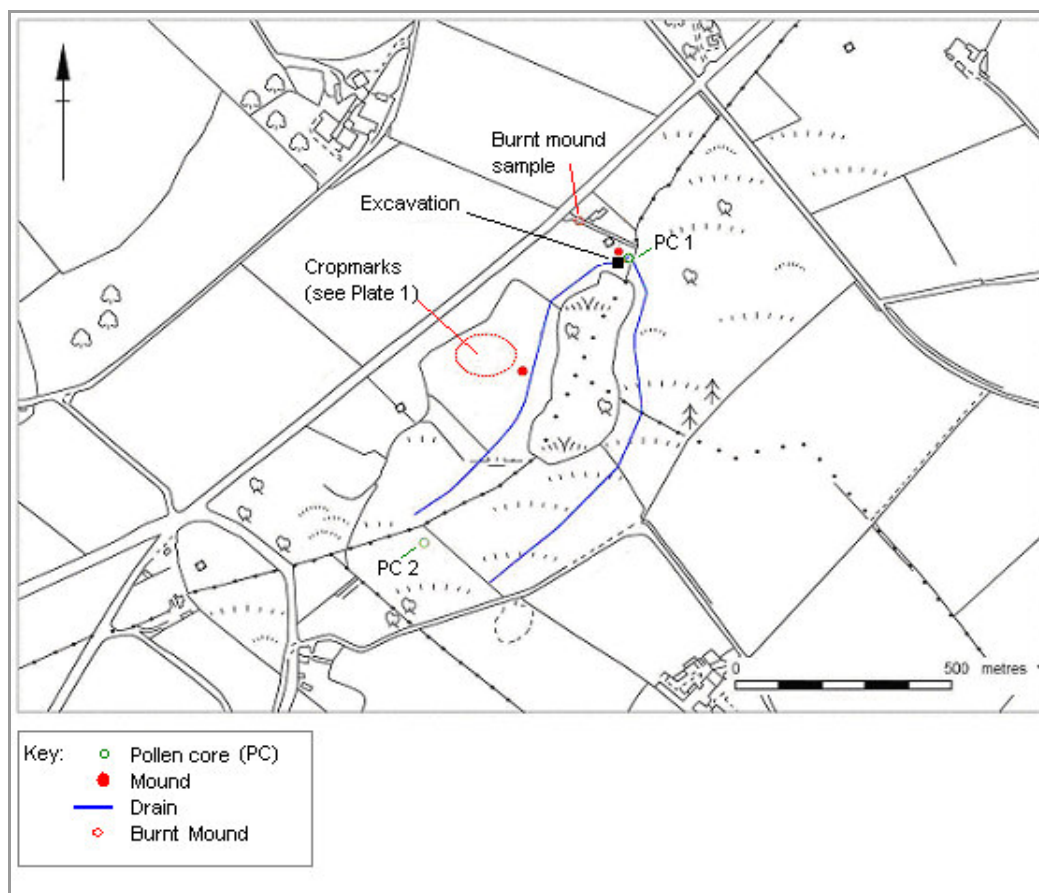

Figure 3. Map showing the location of excavation, pollen cores and nearby sites.

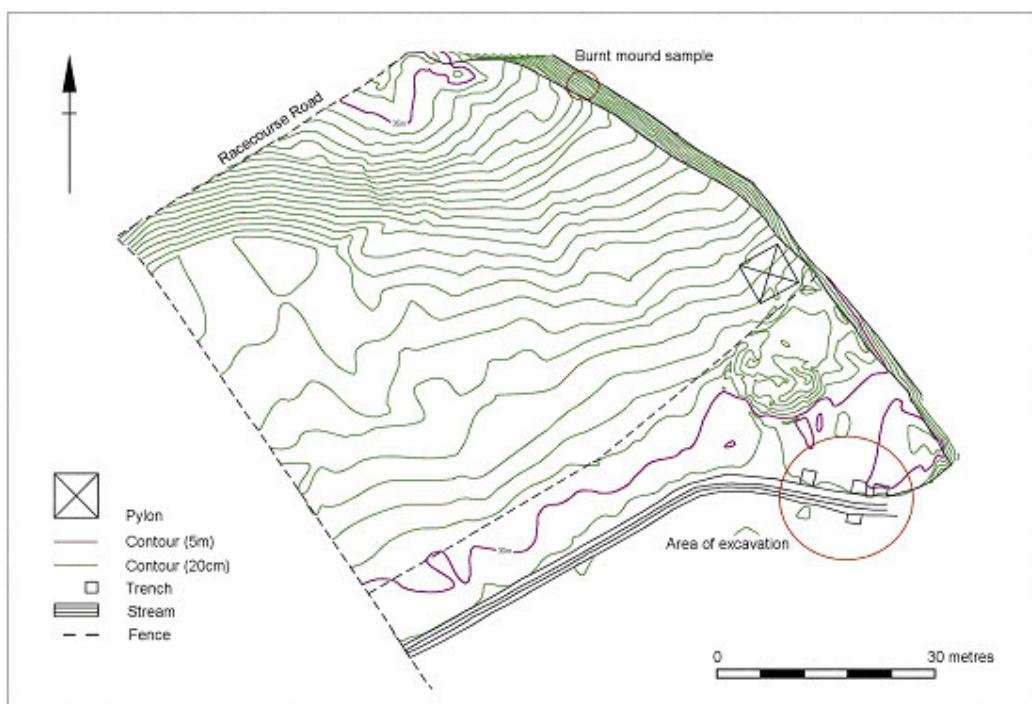

Figure 4. Contour map of the area of the excavation, mound and burnt mound.

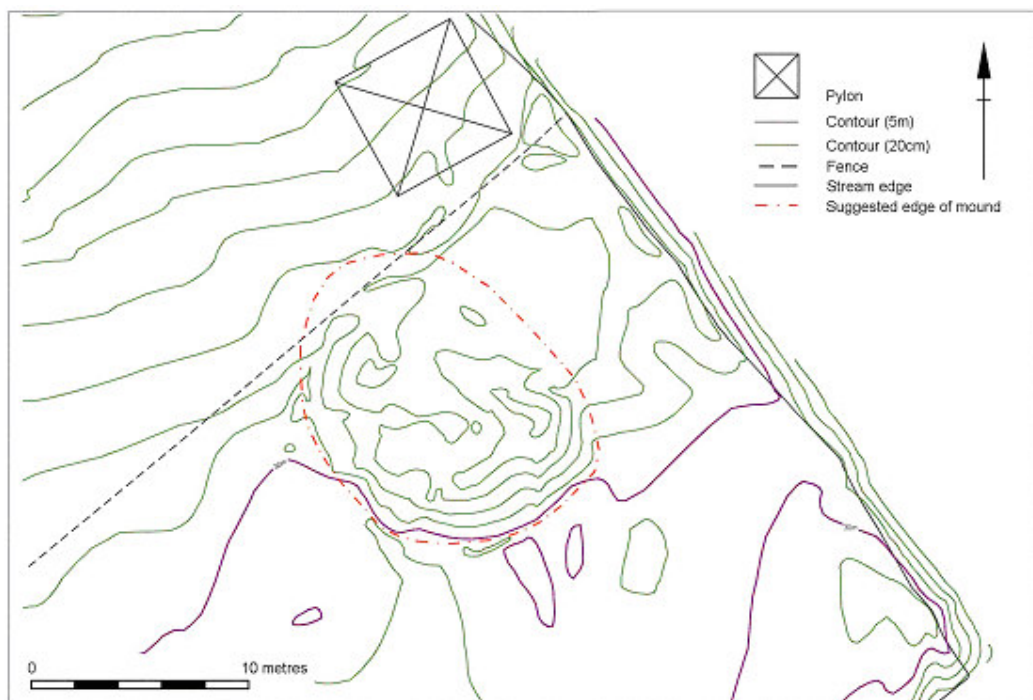

Figure 5. Contour map of mound.

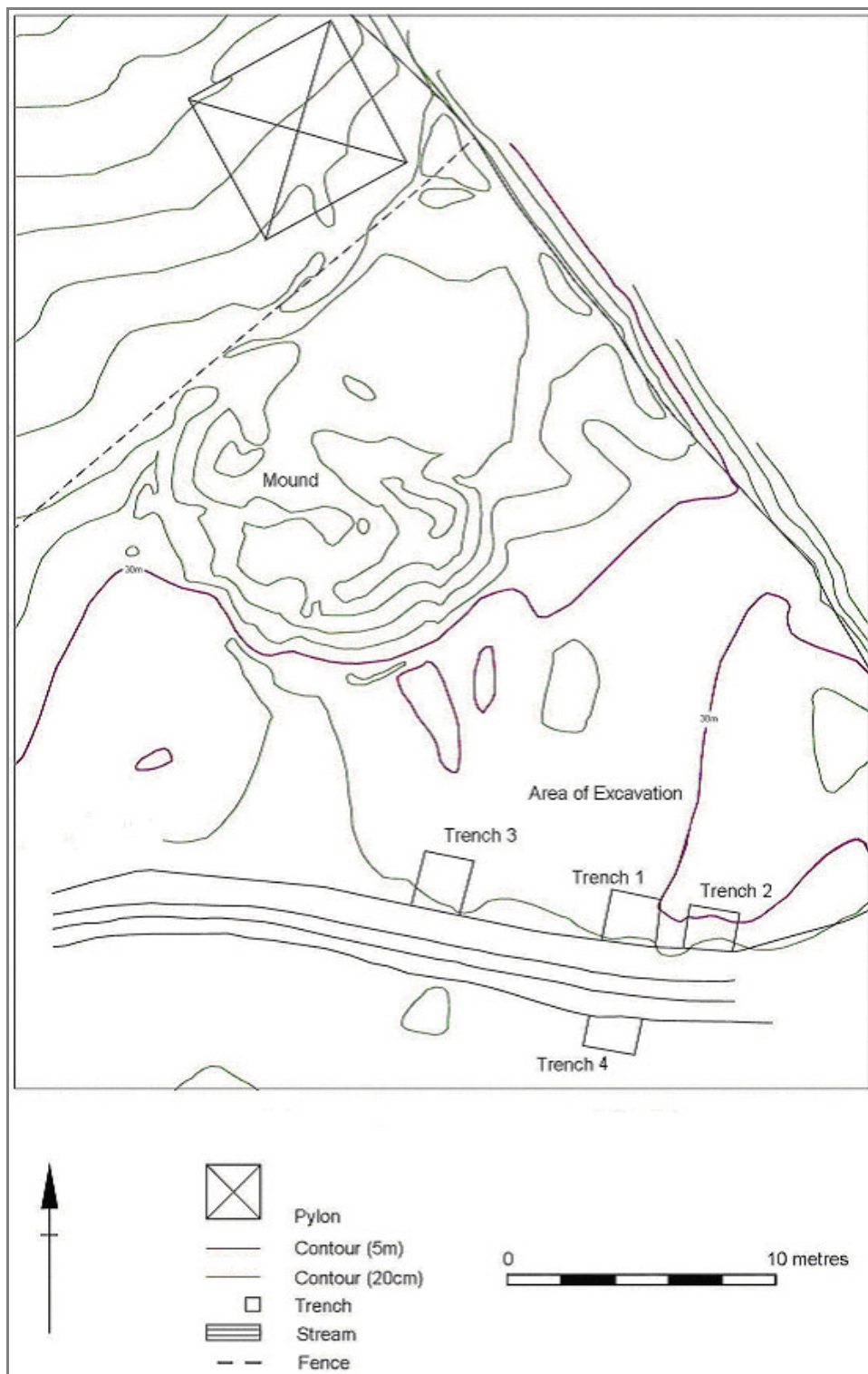

Figure 6. Plan showing the mound and the location of the excavation trenches.

3. Topographic Survey

Keith Adams and John Ó Néill

3.1 Methodology

3.1.1 The detailed topographic survey of the area around the site was undertaken concurrently with the excavation. The survey was conducted using a TCR705 Leica Total Station. The topographic survey was tied into the survey of the Ballynashallog, Springfield Road site (excavated under licence number AE/02/54) and the Irish National Grid.

3.1.2 The survey data was transferred and processed using Leica LISCAD6.0 software. Additional processing of the survey data was undertaken using Surfer 8.0 software.

3.2 Results of the topographic survey

3.2.1 The results of the topographic survey are illustrated as both a contour map of the general area around a detailed contour survey of the adjoining mound. The area of the survey included the burnt mound in the field to the north of the occupation site, the unclassified mound, the occupation site and the adjoining areas. The overall results are shown in Figure 4.

3.2.2 The detailed survey of the unclassified mound is shown in Figure 5. From the geodetic survey, the mound is currently 16 m in length, 12 m in width and 1 m in height, and is roughly oval in shape (see also Plate 2). The shape of the mound at the south-eastern corner suggests that two basic phases of deposition occurred.

3.2.3 A largely circular feature present on the northern and western side of the mound appears to have been buried under soils excavated during the cutting of the drainage ditch along the eastern side of the field. It is possible that hill wash has also developed over the north side, as the down slope side of the mound seems to represent the best surviving portion. There was no suggestion from the topographic survey that a ditch or outer bank is present at the site.

3.2.4 On the basis of the detailed survey of the mound, its original form appears to be circular, with a height of 1 m and a diameter of 12 m. This was subsequently buried under soils removed from the area to the east of the mound during the construction of a substantial drainage channel which separates the park area from the farm adjacent to the site. It is quite likely that the construction of the original circular mound represents a phase of activity distinct from the archaeological deposits described below.

4. Environmental Sampling.

Thom Kerr and John Ó Néill

4.1 Introduction

4.1.1 As part of a wider project involving the excavations at Thornhill in 2000 (Logue 2000) and at Ballynashallog (Springfield Road) and Ballyarnet in 2002, a programme of sampling for palaeoecological analysis was undertaken as an integral part of the 2002 investigations. The coring of the archaeological soils was supervised by Dr. Nicki Whitehouse, Phil Barratt, Dr. Rick Schulting, Thom Kerr and John Ó Neill.

4.2 Sampling Strategy

4.2.1 Potential sampling sites were examined in the general area around the new Thornhill School, and the Ballyarnet Lake and adjoining fen lands was identified as the most suitable candidate. The presence of Cordoned Urn at the occupation site (LDY14A:026) provided a rough *terminus ante quem* for the peat deposits beneath the structure of around 1800 – 1500 Cal BC (see discussion in Section 6.2.4 below). Initial probing demonstrated that more than 1.50 m of peat was present below the occupation deposits, suggesting that samples of peat, which had formed during the occupation of the Thornhill site in the early third millennium or fourth millennium BC, could be recovered. Subsequently, 4.50 m of peat deposits were recorded beneath the occupation site.

4.2.2 On the basis of the preliminary examination of potential sampling sites, a number of cores were then taken through the peat deposits around Ballyarnet Lake, the locations of which are indicated on Figure 3. At the Ballyarnet occupation site, the sampling programme was undertaken in tandem with the excavations.

4.2.3 Parallel cores, with a 200 mm overlap, were taken at the two locations indicated on Figure 3. Pollen Core 1 was located to the immediate west of the occupation site and reached a maximum depth of 4 m. Some glacial clays were noted at the base of this core. Pollen Core 2 was taken from the lake basin, where some 9 m of peats were identified as present. Glacial clays were identified from 3.80 m.

4.2.4 A monolith was taken from the exposed drain face in which the archaeological deposits were exposed. The monolith was taken through peat deposits which had formed during the occupation of the site. The peat stratigraphy at this location was recorded as per the following table (Table 1).

Depth below surface (m)	Colour	Description
0 – 0.22	5YR 2.5/1 (Black)	Silt with some clay. Layer of grit and gravel at 0.15 m (recorded as 102 etc during excavation, see below).
0.22 – 0.47	10R 2.5/1 (Reddish Black)	Well humified peat and visible wood content. Very abrupt boundary between peat and mineral layer above.
0.47 – 0.575	5 YR 2.5/1 (Black)	Very well humified peat with some silt.
0.575 – 0.98	5 YR 2.5/2 (Dark Reddish Brown)	Less humified than top peat layers – visible wood content. Wetter, therefore, less of degradation of plant remains.

Table 1: Peat stratigraphy at location of monolith.

4.3 Insect Sampling (by Thom Kerr)

- 4.3.1 Some initial processing of the monolith was undertaken to establish the potential of the samples. Two 1 litre samples were processed from the monolith, Sample 1 at a depth of 0.10 – 0.20 m and Sample 5 at a depth of 0.50 – 0.60 m. Sample 1 produced very few Coleopteran remains, possibly due to the highly sedimentised and desiccated nature of the sample. Sample 5 had a lower than expected number of insect fossils. Those recovered included a mixture of aquatic (e.g. *Gyrinus sp.* and *Hydraena brittenii/riparia*) and land-based insects (e.g. *Steniscus sp.*). These are typical species that would be found at the end of fen or forest fen.

Sample No.	Nigor	Stratification	Elasticas	Siccitas	Humicity
1	2	0	1	3	1
5	4	3	3	1	4

Table 2. Physical properties of samples.

Key:

Nigor: degree of darkness (0 = white; 4 = black)

Stratification: degree of stratification

Elasticas: degree of elasticity (0 = plastic clay; 4 = fresh *Sphagnum* peat)

Siccita: degree of dryness (0 = clear water; 1 = saturated peat; 4 = air dry peat)

Humicity: degree of decomposition in peat (0 = fresh; 4 = almost all of matrix can be squeezed out).

Sample No.	Components	Volume of Flot	Flot Description	Preservation	Fragmentation
1	Ga3/Th1	75 ml	Clean with high percentage of gravel and reasonable plant preservation	1	High
5	Sh4	150 ml	Flot full of organic materials, with few Chironomids	2	Average

Table 3. Processing results.

Key:

Components (expressed on 0 – 4 scale): Ga = silt (grains 0.06 – 0.6 mm); Th = *turfa herbacea* (roots and connected stems of herbaceous plants); Sh = *substantia humos* (Dark disintegrated humous substance).

Preservation: 1 = Very poor (Only the most robust, highly sclerotised taxa, i.e. ground beetles and weevils, present, although eroded and testaceous. Identification can only be expected to genus level. 2 = Poor (Testaceous, even amongst more robust groups, and the more weakly sclerotised taxa eroded. Some identification to species level may be expected).

Fragmentation: Low/average/high.

4.4 Burnt Mound LDY14A:025

- 4.4.1 In the course of the topographic survey outlined above, it was noted that the burnt mound, LDY14A:025, visible in section in the drainage ditch to the east of the excavated site, was still actively eroding into the drainage ditch. As part of the broader sampling strategy, a sample of the charcoal, which was eroding from the section, was retained for further analysis. This sample was recorded as Sample 6000.

5. Excavation

5.1 Methodology

5.1.1 The excavation was carried out by examining the archaeological materials exposed within the drainage ditch and then opening four separate trenches, labelled Trenches 1 to 4, across the top of these deposits. Each trench measured 2 m by 2m, although there were slight variations in each trench, depending on the nature of the edge of the drainage ditch in which the archaeological deposits had been originally exposed. Trenches 1 and 4 were opened facing each other, across the area where the stratigraphy appeared most complex. Trench 2 was opened across the eastern limits of the structure and Trench 3 across the western limits. The exposed sections through the archaeological deposits that were visible in the drainage ditch were cleaned of vegetation and fully recorded to provide an overview of the stratigraphy present on the site. The deposits in all of the trenches were overlain by upcast material from the cutting of the drainage ditch. The excavated features are shown in figure 7. Plate 3 gives an indication of the visibility of the archaeological deposits visible in the drain face.

5.1.2 The excavations were undertaken by hand and the context record for the site was created using the standard context recording method. Individual features were photographed both prior to, and following, excavation and included in a series of overall plans (Scale 1:20) of the site which were prepared throughout the course of the excavation. Section drawings (Scale 1:20) were undertaken of the exposed archaeological deposits within the drainage ditch (for details of site photography see Appendix Three and for field illustrations see Appendix Four). In addition to the photography and illustration, the principal site records consisted of context sheets augmented by separate registers of small finds (Appendix Five) and samples (Appendix Six). Following the completion of the site recording, the excavation trenches were manually backfilled.

5.2 Account of the excavations

5.2.1 It is intended that the Harris Matrices for the site (see Appendix Two) are referred to whilst reading the following accounts of the stratigraphic sequences of Trenches 1 to 4 and the drainage ditch. As many of the deposits were exposed in section, rather than excavated, some are only discussed in sections 5.10.1 and 5.10.2 below.

5.3 Recording the exposed section faces.

5.3.1 Recording the faces of the 1 m deep drain that had been cut through the fen was considered to be the simplest method of gaining a broader understanding of the history and morphology of the structure. To facilitate work in the actual drain, a planked walkway was built across the

drain, and a series of tracking boards were laid on bricks along the base creating a dry surface above the water level. As much of the vegetation as could be safely removed was cut from the banks and the exposed archaeological deposits were cleaned up by trowel and recorded.

5.4 Northern section face of the drain

5.4.1 Recording of the drain face revealed that the archaeological deposits spread over some 11 m (see Figure 8). The vegetation was removed from the section face, which was then trowelled to record the depositional sequence. The exposed portion of the deposits was then drawn, photographed and recorded.

5.4.2 A number of artefacts were retrieved during the cleaning of the section, including a fine tanged arrowhead (basalt), sherds of Cordoned Urn and metalworking debris. The arrowhead (see Plate 4) was found beside a portion of the original timber platform (5017), at the base of 103, a layer of mid-brown silty clay. The sherds of Cordoned Urn were found in a charcoal-rich deposit of silty clay (104) deposited directly onto the timber platform.

5.4.3 An *in situ* post (*Quercus*) was identified at the western end of the structure (307). Examination of the base of the drain revealed three further posts, all potentially *in situ*. These were recorded as 306, 308 and 309. One of the axed posts (307) is shown in Plate 5.

5.4.4 The basic morphology of the structure could be identified from this section face, with a layer of timber at the base, an enclosing palisade and a series of dumped or accumulated deposits overlying both features. This is discussed below in Section 5.10.

5.5 Southern section face of the drain.

5.5.1 The southern face of the drain was more heavily disturbed than the northern face. Some traces of the archaeological deposits could be identified across 9 m of the drain face (see Figure 9). The vegetation was removed from the section face, which was then trowelled to record the depositional sequence. The exposed portion of the deposits was then drawn, photographed and recorded. Recent root action had severely disturbed much of the western part of the section face.

5.5.2 Finds recovered during cleaning of the section face included some sherds of coarseware, two flint scrapers and a hollow or concave scraper, mainly from soils disturbed by root action.

5.5.3 The same basic sequence was visible as in the northern face, with a basal timber platform overlain by deposits of archaeological soils. A single palisade post (308) was identified at the western end of the section face.

5.6 Trench 1.

5.6.1 Trench 1 was centrally placed on the northern side of the drain and measured 2 m by 2 m, with the southern limits conforming to the edge of the drain. This trench was to establish the upper surface level of the structure and examine some of the features identified at this level.

5.6.2 Two limestone flagstones were identified directly below the sod (101), at a depth of 50 mm. They measured 0.40 m by 0.28 m and 0.60 m by 0.22 m. Some fragments of wood, stones and finds were recovered at this level. Excavation was then confined to the 1 m wide portion of the trench adjacent to the drainage ditch, to allow the limestone flagstones to be retained *in situ*. The soil deposit present in the trench was removed until a thin layer of gravel and sand (102) was encountered at a depth of 0.18 m. Subsequent examination of the soil matrix underlying the stones and that excavated in the 1 m portion adjacent to the drainage ditch suggested that they represented the same layer. The position of the stones so close to the surface suggests that they are present within a mixed topsoil deposit (101) representing upcast material removed during excavation of the drainage ditch. Similar stones were recorded in Trench 4 as 404. Flint, pottery and metal working debris were recovered from 101, along with some modern finds.

5.6.3 From the exposed sections, the thin gravel and sand layer (102), seems to seal the *in situ* prehistoric deposits. Thus, with the upper surface level of the archaeological deposits established, the trench was covered in plastic and back-filled.

5.7 Trench 2.

5.7.1 Trench 2 was located 1 m to the east of Trench 1. The trench was laid out along the same baseline as Trench 1, with the northern limits parallel and at 2 m from the edge of the drainage ditch. The more disturbed upper edge of the drainage ditch did not allow for the clean excavation of a 2 m by 2 m trench, with the southern 0.40 – 0.60 m having largely subsided into the drain some time previously. Following excavation of the topsoil, some traces of the gravel layer (102) were identified and recorded as 202. Removal of the topsoil did not reveal the consistent presence of 202, and further excavation was confined to a roughly 1 m wide section, 0.40 m from the northern limits of the trench.

5.7.2 The removal of 201 and 202 exposed a deposit of burnt stone and charcoal-rich clay (204). A sample of 204 was removed from the section and recorded as Sample 6001. Two deposits of

very dark greyish brown, silty, sandy clay were identified as overlying 204 and labelled as 210 and 211. Both were oval and measured 0.20 m by 0.14 m and 0.20 m by 0.19 m respectively. Excavation of 210 revealed it to be present to a depth of 0.15 m in a tapering cut, which was labelled 209. This was considered to be a possible posthole and the deposit 211 was considered to be similar and a provisional number of 212 was assigned to the cut.

5.7.3 Flint, pottery and metal working debris were recovered from the topsoil layer in this trench (201). The trench was covered in plastic and back-filled.

5.8 Trench 3.

5.8.1 Trench 3, the westernmost of the trenches on the northern side of the drain, lay 5 m to the west of Trench 1, at the edge of the stratigraphic sequence visible in the drain face.

5.8.2 Excavation of the upper, topsoil deposit (301) produced some partly dried worked timbers which must have been re-deposited here during the excavation of the drainage ditch. A sand and gravel deposit (302) was uncovered at a depth of 0.14 m. This was similar to 102 and 202.

5.8.3 As a palisade post (307) was visible in the section of the drainage ditch adjacent to the trench, a 0.40 m portion of the southern end of the trench was excavated to try and identify any further *in situ* posts. Excavation of 302 revealed the top of two further posts, with fen peat on the western (outer) side and some traces of 303, a very dark grey-brown silty clay recognised in the exposed section of the drainage ditch. The palisade posts measured 170 mm (305) and 277 mm (310) in diameter. Both were removed as samples for dendrochronology and other specialist analysis.

5.8.4 Flint, pottery, a rubbing stone and metal working debris were recovered from the topsoil layer in this trench (301), but no finds were recovered from 302 or 303. The trench was covered in plastic and back-filled.

5.9 Trench 4.

5.9.1 Trench 4 was opened directly opposite Trench 1. A number of large limestone flagstones were visible in section, and the upper portion of this trench had been cleaned and examined during the original inspection of the site which it was discovered. As such, plants had re-colonised the area around the northern portion of the trench, with the root action affecting the archaeological soils. A quantity of the archaeological soils appear to have subsided into the drainage ditch sometime after it was constructed (perhaps due to the weight of the stones),

which is why the stratigraphic sequence depicted in the section drawing (Figure 9) is discontinuous at this point.

- 5.9.2 The topsoil layer (401) was 0.15 m deep, and produced a large quantity of pottery including a base, possibly of a Cordoned Urn pot, and a rimsherd of a decorated pot, with an applied cordon and some comb-impressed decoration which is also likely to be a Cordoned Urn. Some flint and some large pieces of metal working debris were also recovered from the topsoil.
- 5.9.3 Once the topsoil was removed, a complex stone and fire-hardened clay feature was identified within the trench (see Plate 6). This was visible in section where the archaeological deposits were exposed in the drainage ditch or through subsidence. The remaining elements suggest a double line of stones (404) extending for some 0.70 m into a dome of fire-hardened clay. The basal layer of the fire-hardened clay (406/415), up to 20 mm thick, was visible in section as overlying a deposit of very dark grey-brown silty clay (403), which itself overlay a deposit of burnt stone and charcoal (405). The exposed portion of the clay dome element of the feature measured some 2 m (east-west) by 1.2 m (north-south). A series of further layers of fire-hardened clay were present, each separated by a deposit of black clayey silts. These layers are recorded in Figure 9 as 407 - 415. A sample of 407 was retained for analysis as Sample 6003, and a sample of 408 was retained as Sample 6004. At the southern end, this feature overlay the deposit of burnt stone and charcoal recorded as 405. This domed feature seems to represent some form of kiln or furnace, similar to a second feature visible in section below Trench 1.
- 5.9.4 Once this feature was recorded, no further excavation or removal of associated deposits was undertaken and it was then covered in plastic and back-filled.

5.10 *Phasing of the stratigraphic sequences*

- 5.10.1 The Harris Matrices of Trenches One to Four have been provisionally phased (see Appendix Two). The phasing of the archaeological deposits is largely dependent on the exposed sections of the drain. This has allowed for the creation of a basic stratigraphic sequence, although, without fuller excavation this sequence must be treated with some caution.
- 5.10.2 The initial phase saw the construction of a palisade and timber platform. This was followed by an occupation sequence, divided here into four phases. The four-phase division is based around the main characteristics of the archaeological deposits.
- 5.10.3 Two furnace-type features are present, in the exposed section below Trench 1 (206 – 208) and in Trench 4 (404, 406 – 415, as described above). These two features represent the

beginning and end of the occupation sequence (i.e. Phases 1 and 4). A layer of silty clay (304), similar in composition to 208 may be contemporary with the feature recorded as 206, 207 and 208. Two types of deposit stratigraphically separate these features. Deposits of burnt stone and charcoal are present in both section-faces (204, 405), and have been provisionally assigned to a Phase 2 of occupation. These deposits seal the Trench 1 'furnace' and are overlain by the (Phase 3) mid-brown silty clay deposits labelled as (variously) 103, 203, 303, 403 and 417. On the basis of the stratigraphy, the Trench 4 furnace post-dates these clays and has been designated as representing a fourth phase of occupation of the structure.

- 5.10.4 The whole occupation sequence is sealed by the layer of gravel and small stones (102, 202, 302, 402 and 416). Some further peat formation and upcast soils were present above this layer and recorded as the topsoil (101, 201, 301, 401).

5.11 *Artefactual Dating*

- 5.11.1 A quantity of lithics, pottery and other finds were recovered during the excavation (see Appendix Five). Provisional analysis of the artefacts suggests that they are consistent with a single cultural phase, dated by the presence of sherds of Cordoned Urn (see Plate 7) and a tanged arrowhead. The available dates for Cordoned Urns would place the occupation phases in the period from 1800 BC to 1500 BC (see discussion in Section 6.2.4 below). The type and form of the lithics present on the site would be consistent with this type of date (M. O'Hare, *pers.comm.*). Further evidence for a mid-second millennium BC date can be found in the toolmarks present on the base of the palisade posts (305 - 310). The type and form of these toolmarks are consistent with flat bladed bronze axes.
- 5.11.2 Some 34 pieces of metal working debris, mainly slag, were recovered during the course of the excavation (information from Ian Meighan), some from each trench. Further analysis of this material is required before any definitive statement can be made as to the type of metal being worked. Although, it could be pointed out that the absence of mould fragments suggests a date prior to the Late Bronze Age, which is not inconsistent with the evidence discussed in Section 5.11.1.

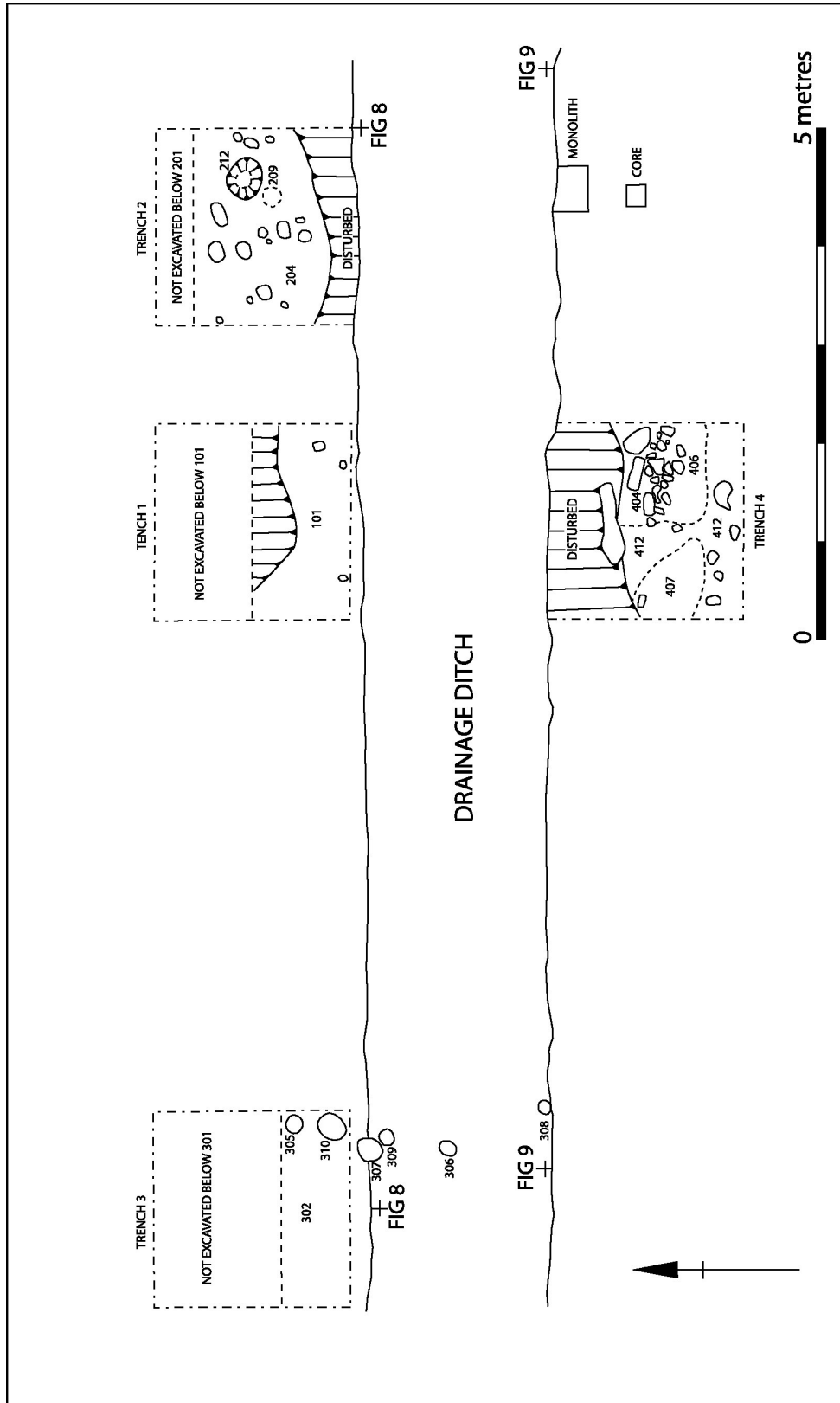

Figure 7: Plan of excavated features.

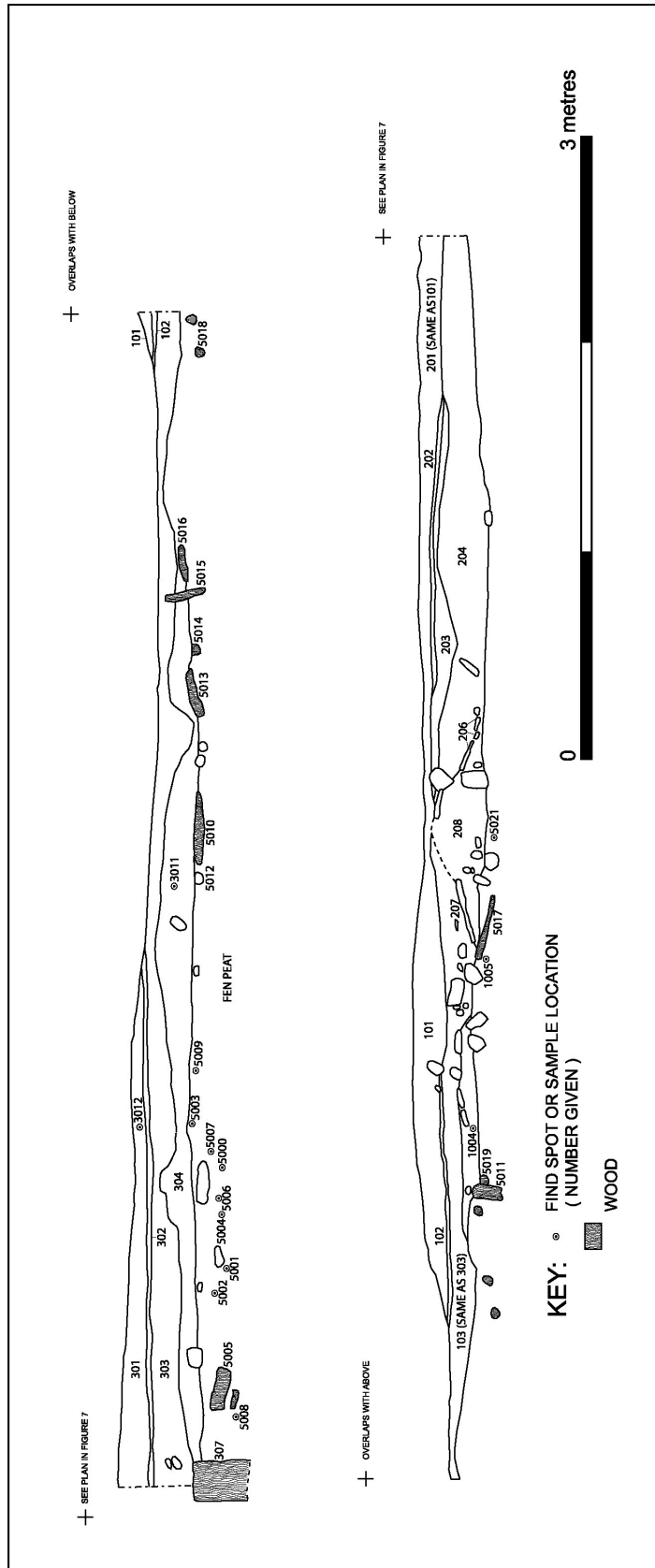

Figure 8: Section of drain (northern side).

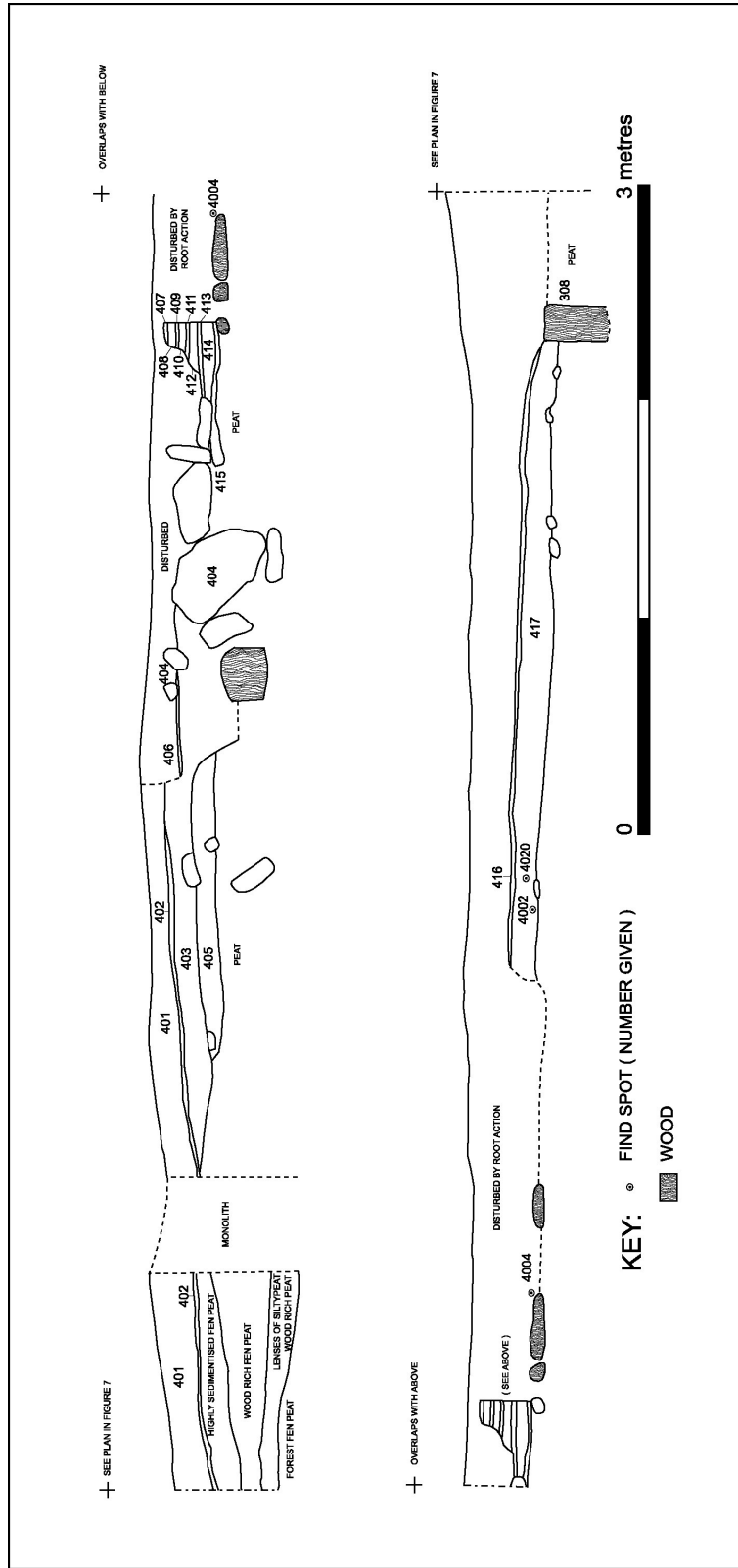

Figure 9: Section of drain (southern side).

Plates



Plate 1: Aerial photograph of Ballyarnet Lake, dated 16th August 2002, with inset of main cropmark features: reference V(SVY)S058(D) 16AUG02 02/3974.



Plate 2: View of the mound, to the north of the occupation site, from the east.



Plate 3: View of the possible furnace (Phase 1), in section below Trench One, from the south.



Plate 4: Find 1003, a causeway basalt tanged arrowhead, from 103.



Plate 5: Palisade post 306, after excavation.



Plate 6: Various finds of Cordoned Urn sherds, from the Ballyarnet occupation site.



Plate 7: View of the possible furnace (Phase 4), in Trench Four, from the south.

6. Results and Discussion

6.1 Results

- 6.1.1 The 2002 investigations at Ballyarnet have partially ascertained the character and date of activity at the occupation site. However, the potential of the initial analysis of the data gathered during the excavation is largely constrained by the limited nature of the excavation. Consequently, any discussion of the excavation results is inevitably provisional and speculative.
- 6.1.2 The archaeological deposits at Ballyarnet are defined by an initial timber platform, retained by a palisade. Six posts of the palisade were removed during the excavations, along with three posts disturbed during the original construction of the drainage ditch. An initial examination suggests that oak, alder and hazel are present. None of the oaks had had sufficient year rings to provide a date for the last year-ring (D. Brown *pers.comm.*). Given the diameters of the oaks (up to 277 mm), they appear to have grown under optimum conditions.
- 6.1.3 The highly sedimented nature of the upper peats at Ballyarnet and the low coleopteran content are consistent with the drainage which has taken place around the lake. The increasing humification of the lower peats, from the upper surface deposits down to 0.98 m, might not be simply a product of the modern alterations to the local hydrology, and could indicate a change in the peat-forming environment. Alternatively it could be consistent with contemporary fluctuations in the water-table of the lake and changes in discharge or deforestation of the lands upslope of the site. Further light should be shed on these issues through a programme of analysis of the environmental samples.
- 6.1.4 Future management and protection strategies for the site may need to consider the degree of the threat posed by the drainage of the fen to the integrity of the structure, and its waterlogged components. The removal of moisture from sensitive artefactual material - such as microfaunal and microfaunal material, textiles, basketry and other organic materials - leads to serious loss of structure and complete decay of the artefactual material. It may be prudent to consider this factor in future management strategies for the site. The 'do nothing scenario' would prevent further destruction of the site through excavation, although, in the long term, it would also see the loss of all but the most robust of the archaeological materials, such as inorganic artefacts, charcoal and clays. It would be possible to either construct a membrane across this section of the drainage ditch to preserve the deposits *in situ*. Alternatively, the drainage channel could be diverted around the structure. Both of these options would require further excavation to facilitate construction of the membrane and to ascertain the extent of the site, and to identify a suitable course for the new drain. The absolute solution would be to

seek preservation by full record, although this would be the most costly option, since it would require a complete excavation.

6.2 Discussion

- 6.2.1 Parallels for the archaeological materials present on the site can be found in the existing archaeological record. The sequence of deposits which represent the occupation phases include substantial amounts of burnt stone and charcoal, conventionally classed as burnt mound deposits (e.g. see Buckley 1990). Similar deposits are known from other settlement sites where Cordoned Urn has been recovered (e.g. see Waddell 1995), such as Meadowlands, Co. Down (Pollock and Waterman 1964), Moynagh Lough, Co. Meath (Bradley 1991), The Heath, Co. Laois (Keeley 1993), Kilbride, Co. Wicklow (Breen 1997) and Rathmullan, Site 10, Co. Meath (Bolger 2000). In the recording of the exposed sections, these deposits were assigned to Phase 2.
- 6.2.2 Another site, located in peat deposits, and with a complex series of features including a substantial quantity of burnt stone and charcoal, is Killymoon in County Tyrone (Hurl 1995). At this site domed layers of fire-hardened clay were uncovered similar to the Phase 1 and Phase 4 features at Ballyarnet. This phase of occupation of the site was subsequently dated to the end of the Bronze Age, with a mid-second millennium trackway located beneath the occupation levels. The function of these features was unclear at Killymoon, but at Ballyarnet the presence of quantities of metal working debris (also present in small quantities at Killymoon) suggests some functional connection between the two.
- 6.2.3 Cordoned Urn sherds and undecorated coarse ware were recovered from the archaeological deposits and the topsoil/upcast deposit and both traditions appear to be present during the main phase of occupation of the site (e.g. finds from 104 and 417). The presence of sherds of several Cordoned Urns allows us to suggest a possible date range for the structure.
- 6.2.4 The available dates for Cordoned Urn are shown in Figure 10, with calibrated ranges centring on 1900 Cal. BC to 1400 Cal. BC. A brief examination of the source of these dating samples allows us to constrain this date range. The dates for Altanagh (Williams 1986) are from "charcoal" (F169), "carbon from the interior of the Cordoned Urn" (F170) and "hazel and willow charcoal" (F171); the dates for Ballintubbrid (Mount and Hartnett 1993) are from "charcoal" in a pit containing Cordoned Urn, a battleaxe and cremated bone; the dates for Kilcroagh are from "carbon adhering to a sherd" (OxA-2673; Hedges *et al* 1993) and "oak charcoal" (GrN-15378; Williams *et al* 1991-2); the Downpatrick dates are from the phase associated with Cordoned Urns (Pollock and Waterman 1964) and were from "charcoal" retrieved from structural features (Smith *et al* 1973); the date from Moynagh Lough was derived from "charcoal" in a layer containing Cordoned Urn pottery (Bradley 1991). The last

three dates included in Figure 10 represent the best correlations between the sample and the activity which is being dated (Altanagh F179; Altanagh F171; Kilcroagh sherd of Cordoned Urn). These dates do not constrain the overall distribution much more than to between 1800 Cal. BC and 1500 Cal. BC. A radiocarbon determination for bark or the outer rings of one of the palisade posts at Ballyarnet might be expected to fall into this range. Alternatively, a pre-1800 Cal BC date may suggest that the duration of occupation is much longer, given that a date range of 1800 Cal BC to 1500 Cal BC can be proposed for the Cordoned Urns.

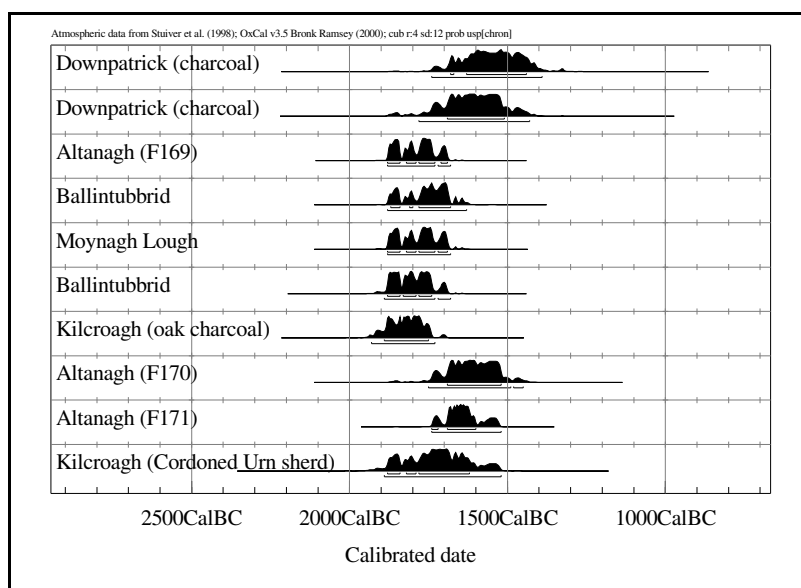

Figure 10: Calibrated dates for Cordoned Urn.

- 6.2.5 A preliminary examination of the lithics has revealed that the tanged arrowhead is of Ballyclare type (M. O'Hare *pers.comm.*) and is made from basalt, probably Causeway Basalt (I. Meighan *pers.comm.*). The use of non-flint or chert sources for tanged arrowheads is not unparalleled as a rhyolite tanged arrowhead has been recovered from Monvoy., County Waterford (Zvelebil, Moth and Peterson 1989). At least 21 pieces of chipped or modified flint were present, along with two pieces of chipped quartz. The nature of the lithics at Ballyarnet appears to be consistent with the date range for Cordoned Urns.
- 6.2.6 The topographic survey, environmental sampling and available aerial photographs suggest that the occupation site is merely a single element of a more complex archaeological landscape. The topographic survey included the mound immediately to the north of the occupation site (part of LDY14A:025), as well as the location of a burnt mound (LDY14A:025). A second, unclassified, mound lies in a field to the south-west (LDY14A:021) and further burnt mounds have been recorded in the vicinity. An aerial photograph, taken in August 2002, shows an oval enclosure and some smaller circular enclosures in the field to the south-west of the site, adjacent to the mound described above. This suggests that a complex of

monuments and structures is present around Ballyarnet Lake, as is similarly the case at other lakes in Ireland (see O'Sullivan 1998). The relationship of the mound to the occupation deposits is unclear. It may represent a high point of the stratigraphic sequence activity associated with the main occupation site, similar to those occasionally noted on crannógs.

- 6.2.7 The presence of the layer 102/202/302/402/416 may be significant when examining the relationship of the occupation site to both of the unclassified mounds. Since the oaks felled for the construction of the palisade at the occupation site grew under optimum conditions, it is possible to propose that the occupation coincided with a period when the water table was low, relative to the surface of the fen. A dry period would allow certain flora to colonise the fen and take root in locations of significance in the overall hydrology of the lake system.
- 6.2.8 The thin layer of gravel and small rounded stones which is present across the top of the site (i.e. 102/202/302/402/416) may indicate an inundation, post-dating the occupation of the site (and possibly leading to the abandonment of the structure). The inundation could have occurred due to alterations in the lakes hydrology during a dry period, possibly in the form of dense plant growth around the stream draining the lake to the north-east. If this is the case, the extent of Ballyarnet Lake, prior to the modern drainage programmes, might place the two unclassified mounds on, or within, the margins of the lake. This allows us to suggest that while the occupation deposits accumulated during settlement of the fen, similar to other known Bronze Age sites such as Cullyhanna (Hodges 1958), Clonfinlough (Moloney *et al* 1993) and Killymoon (Hurl 1995), the two mounds may have been built in the lake itself identifying them, potentially, as crannogs or lake settlements (e.g. O'Sullivan 1998) dating to a period when the lake waters were higher than present.
- 6.2.9 The cores taken through the peat deposits around the lake edge suggest that a detailed post-glacial record can be recovered through detailed analysis of the samples. On the basis of the level of the occupation site, this record should include both the wider context of the Neolithic occupation at Thornhill (Logue 2000) as well as the occupation site itself.

7. Recommendations for further work

7.1 *Introduction*

7.1.1 Three principal recommendations for further work on the Ballyarnet Lake project are made. Firstly, it is proposed that a limited programme of post-excavation analysis, including dating, of material recovered during the 2002 excavations should be undertaken; secondly, it is recommended that analysis of the environmental samples recovered during the 2002 season be undertaken, and thirdly, it is recommended that a second season of excavations at the site is conducted as part of long term management strategy for preservation of the site. Following completion of the proposed 2003 excavations a revised data structure report will be produced outlining the post-excavation programme required to meaningfully publish both season's of excavations and successfully bring the project to completion. It is not intended to undertake detailed analyses of the finds assemblage until after the completion of the second season of excavations. This will enable finds recovered during both year's of excavation to be studied simultaneously.

7.2 *Programme of post-excavation analysis of materials recovered during the 2002 excavations [to be completed before commencement of second season in 2003].*

7.2.1 Analysis of some of the materials recovered during the 2002 season would inform a second season of excavation work at the site. The identification of the wood samples, to species, the dating of the palisade posts by radiocarbon (in the absence of a suitable dendrochronology sample) and examination of the possible metalworking debris.

7.2.2 Some thirty samples of archaeological wood were taken as samples during the course of the excavation (these are listed in Appendix Six below). Specialist analysis, including identification to species level and the recovery of further information regarding its origin and growing conditions would provide a context for the initial construction of the palisade and timber platform.

7.2.3 In order to examine the issue of the dating of the site a limited programme of radiocarbon dating of material recovered during the 2002 excavations is proposed. As palisade posts were present, with intact bark and sapwood, the dating programme could take one of two forms. Either the bark and some outer rings from two palisade posts could be dated, for comparison to each other and the existing body of contexts from Cordoned Urns were recovered (as discussed in Section 6 above), or a number of dates could be retrieved from a single palisade post to try and obtain a high precision, wiggle-matched date. The latter option would require four radiocarbon dates, the former two.

7.2.4 Thirty-three finds of slag-like material were recovered in the course of the excavations. This material may have been the by-product of metalworking being undertaken on the site. To this end, some specialist identification and analysis should be undertaken to ascertain the origin of this material.

7.3 *Analysis of the Environmental Samples* [to be completed by September 2003].

7.3.1 On the basis of recommendations by Dr. Nicki Whitehouse and Dr. Gill Plunkett of the School of Archaeology and Palaeoecology, a preliminary programme of work should be undertaken to evaluate the environmental samples retrieved during the 2002 investigations. This would involve dating the core and the processing of preliminary pollen samples.

7.3.2 The dating of the core would require one AMS date and some 200 tephra samples to provide a rough chronology of the core.

7.3.3 On the basis of the chronology, 18 preliminary pollen samples will be processed, to provide a skeletal pollen diagram, and if the chronology is sufficiently robust, to examine the period particularly related to the occupation of the nearby site and the site of the excavations at Thornhill/Springfield Road. Depending on results, further work could be carried out at a future date.

7.4 *Further Excavation*

7.4.1 In order to facilitate a long-term management strategy for the archaeological materials at Ballyarnet, and to more fully establish the character of the activities and meaningfully publish the excavations which have taken place, a further season of excavation is recommended. The proposed excavation work is intended to facilitate a preservation strategy, such as outlined in Section 6 and resolve some outstanding issues regarding the site. Of the three options listed in Section 6, the 'do nothing scenario' would prevent further destruction through excavation and not incur any further costs, while the full excavation scenario would require a more detailed break down of potential costs. The following outline is for the median scenario. It will include the following elements:

- The excavation of a trench across the southern side of the drain to allow for the construction of a membrane or for backfilling with sterile material as part of water management strategy. The excavation would seek to locate further traces of the palisade and examine any archaeological feature present within this portion of the site.

- The excavation of a trench across the northern side of the drain to allow for the construction of a membrane or for backfilling with sterile material as part of water management strategy. The excavation would seek to locate further archaeological features in the interior and provide further information on the archaeological deposits exposed in the drainage ditch.
- A trench across the area of a “hearth” described by Mr. Ian Leitch as visible at the time of the original discovery of the site.
- Test-pitting to establish the overall extent of the occupation site.

7.4.2 While the scenario outlined above is based on a putative second season of excavation, it should be stated that any future management strategy for the archaeological resource at Ballyarnet must be in line with requirements and recommendations of Environment and Heritage Service.

8. Bibliography

- Bolger, T. 2000. Rathmullan, Site 10, Co. Meath. In I. Bennet (ed) *Excavations 2000: a summary account of archaeological excavations in Ireland*: 775.
- Bradley, J. 1991. Excavations at Moynagh Lough, Co. Meath. *Journal of the Royal Society of Antiquaries of Ireland* **121**, 5-26.
- Breen, T. 1997. Kilbride, Co. Wicklow. In I. Bennet (ed) *Excavations 1997: a summary account of archaeological excavations in Ireland*: 616.
- Buckley, V. (ed) 1990. *Burnt Offerings*. Wordwell, Dublin.
- Hedges, R.E.M., Housley, R.A., Ramsey, C.B & van Klinken, G.J. 1993. Radiocarbon dates from the Oxford AMS system: Archaeometry datelist 17. *Archaeometry* **35**, 305-326.
- Hodges, H.W. 1958 A hunting camp at Cullyhanna Lough near Newton Hamilton, Co. Armagh. *Ulster Journal of Archaeology* **21**, 7-13.
- Hurl, D. 1996 Ballyarnet, County Derry. In I. Bennet (ed) *Excavations Bulletin: A summary account of archaeological investigations in Ireland 1996*. No. 58.
- Keeley, V. 1993. The Heath, Co. Laois. In I. Bennet (ed) *Excavations 1993: a summary account of archaeological excavations in Ireland*: 140.
- Moloney, A., Jennings, D. Keane, M. and MacDermott, C. 1993. *Excavations at Clonfinlough, Co. Offaly*. Irish Archaeological Wetland Unit Transactions 2. Dublin.
- Mount, C. & Hartnett, P.J. 1993. Early Bronze Age cemetery at Edmondstown, County Dublin. *Proceedings of the Royal Irish Academy* **93C**, 21-79.
- O'Sullivan, A. 1999 *The archaeology of lake settlement in Ireland*. - Dublin : Royal Irish Academy, 1998. - (Discovery programme monograph ; no.4).
- Smith, A.G., Pearson, G.W. & Pilcher, J.R. 1973. Belfast radiocarbon dates V. *Radiocarbon* **15 (1)**, 212-228.
- Waddell, J. 1995 The Cordoned Urn tradition. In I. Kinnes and G. Varndell (eds) *Unbaked Urns of Rudely Shape*. Oxbow Monograph No. **55**.

Williams, B.B. 1986. Excavations at Altanagh, County Tyrone. *Ulster Journal of Archaeology* **49**, 33-88.

Williams, B.B., Wilkinson, J.L. & Magee, R.W. 1991-92. Bronze Age burials at Kilcroagh, County Antrim, and faience beads in Ireland. *Ulster Journal of Archaeology* **54-55**, 48-60.

Zvelebil, M., Moth, E. and Peterson, J. 1989. Monvoy, Co. Waterford. In I. Bennet (ed) *Excavations 1989: a summary account of archaeological excavations in Ireland*: 96.

Appendix One: Context list

Context No.	Trench No.	Description
101	1	Surface deposit of upcast peat and sods.
102	1	Layer of gravel and small stones.
103	1	Mid-brown silty clay.F
104	1	Fine silty clay and peat.
105	1	Fen peat below structure.
201	2	Same as 101
202	2	Same as 102
203	2	Same as 103
		Deposit of burnt stone in charcoal rich
204	2	peat and clay.
205	2	Layer of fired clay.
206	2	Layer of fired clay.
207	2	Layer of fired clay.
		Clay rich deposit of peat sealed by 205-
208	2	207.
209	2	Cut (post hole?).
210	2	Fill of 209.
		Deposit, similar to 209, may be fill of
211	2	posthole.
212	2	Cut containing 211.
301	3	Same as 101.
302	3	Same as 102.
303	3	Same as 103.
304	3	Same as 104.
305	3	Palisade Post.
306	Drain	Palisade Post.
307	Drain	Palisade Post.
308	Drain	Palisade Post.
309	Drain	Palisade Post.
310	3	Palisade Post.
401	4	Same as 101.
402	4	Same as 102.
403	4	Same as 103.
404	4	Stone feature.
405	4	Deposit of burnt stone in charcoal rich

		peat and clay.
406	4	Layer of fired clay.
407	4	Layer of fired clay.
408	4	Charcoal rich silty clay.
409	4	Layer of fired clay.
410	4	Charcoal rich silty clay.
411	4	Layer of fired clay.
412	4	Charcoal rich silty clay.
413	4	Layer of fired clay.

Appendix Two: Harris Matrices

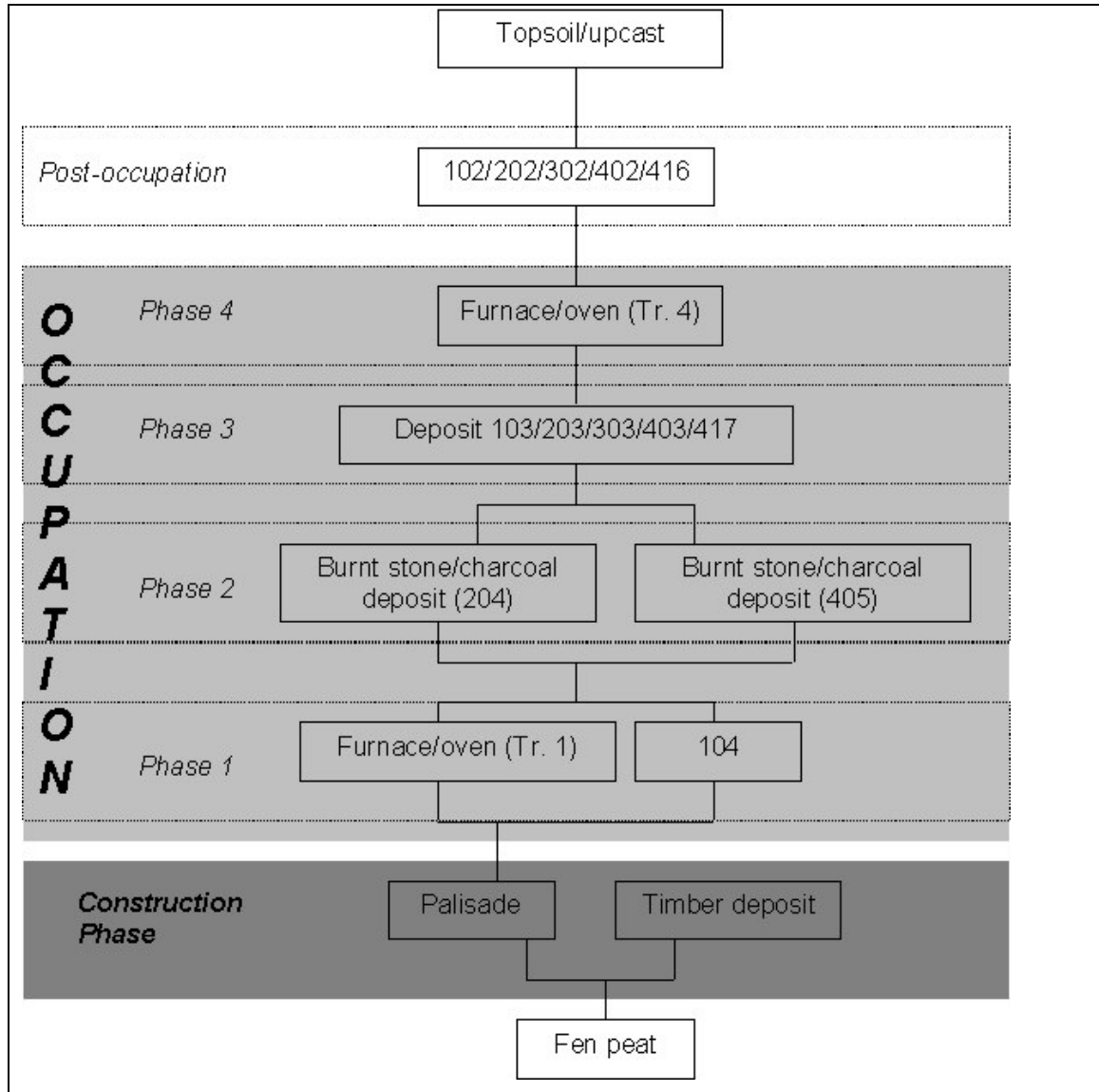

Matrix 1: Schematic overall phasing of the archaeological deposits at Ballyarnet occupation site.

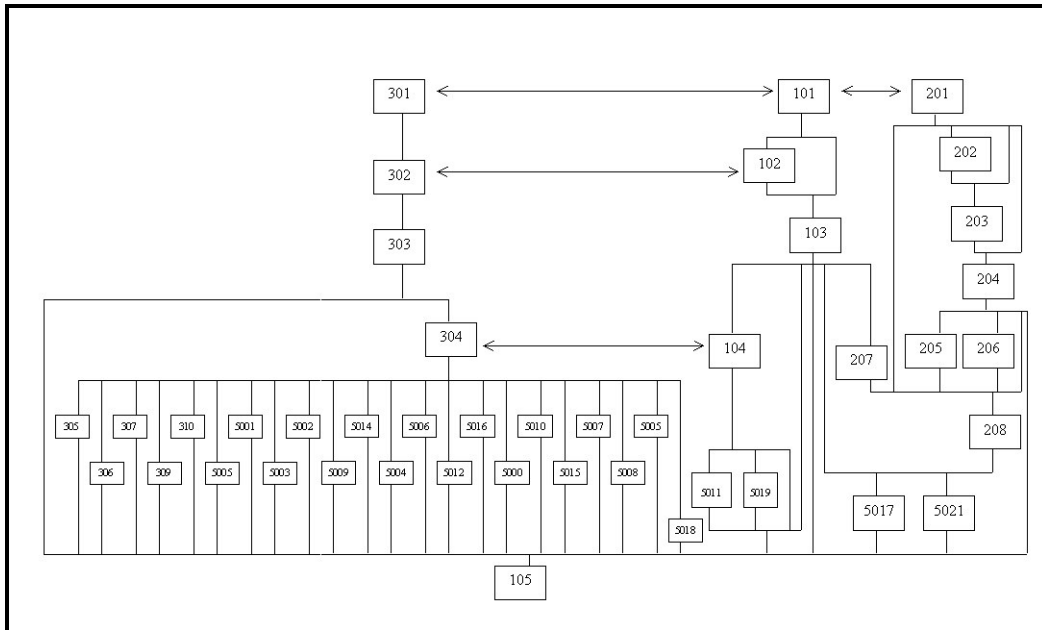

Matrix 2: Matrix for contexts recorded in Trenches 1 – 3.

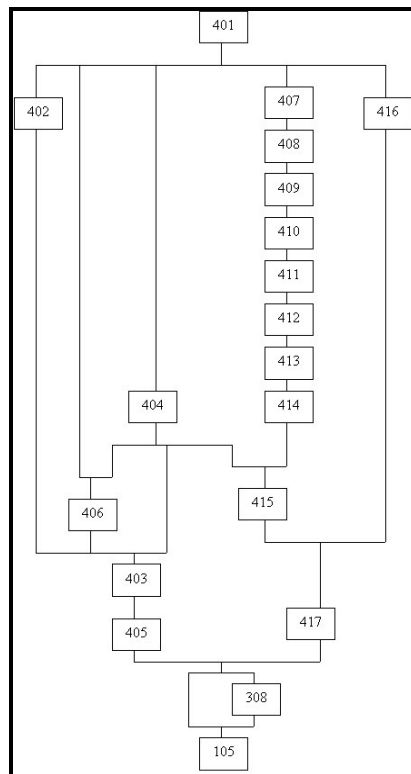

Matrix 3: Matrix for contexts recorded in Trench 4.

Appendix Three: Photographic Record

Film One: Nikon F60: Fuji – 36 Superia 200 colour print film.

- 1 Core One being taken (looking east)
- 2 Core One being taken (looking east)
- 3 Core One being taken (looking east)
- 4 Core One being taken (looking east)
- 5 Core One being taken (looking east)
- 6 Core One being taken (looking east)
- 7 Core One being taken (looking east)
- 8 Core One being taken (looking east)
- 9 Core One being taken (looking east)
- 10 Core One being taken (looking east)
- 11 Trench One, after excavation, from the north.
- 12 Trench One, after excavation, from the north.
- 13 Trench One, after excavation, from the north.
- 14 Trench One, after excavation, from the north.
- 15 Trench Two, after excavation, from the west.
- 16 Trench Two, after excavation, from the west.
- 17 Trench Two, after excavation, from the west.
- 18 View of Trench Three after excavation, from west
- 19 View of Trench Three with posts removed, from west
- 20 View of 305 and 310 on excavation
- 21 View of south facing section of drain overlaps with following.
- 22 View of south facing section of drain overlaps with following.
- 23 View of south facing section of drain overlaps with following.
- 24 View of south facing section of drain overlaps with following.
- 25 View of south facing section of drain overlaps with following.
- 26 View of south facing section of drain overlaps with following.
- 27 View of south facing section of drain overlaps with following.
- 28 View of south facing section of drain overlaps with following.
- 29 View of south facing section of drain overlaps with following.
- 30 View of south facing section of drain overlaps with following.
- 31 View of south facing section of drain overlaps with following.
- 32 View of south facing section of drain overlaps with following.
- 33 View of south facing section of drain overlaps with following.
- 34 View of south facing section of drain overlaps with following.
- 35 View of south facing section of drain overlaps with following.
- 36 View of south facing section of drain overlaps with following.
- 37 View of south facing section of drain overlaps with following.
- 38 View of south facing section of drain overlaps with following.

Film Two: Nikon F60: Colorcare – CN200-24 DXn: 24 colour print film.

- 1 General shots of excavation
- 2 General shots of excavation
- 3 General shots of excavation
- 4 General shots of excavation
- 5 General shots of excavation
- 6 General shots of excavation
- 7 General shots of excavation
- 8 General shots of excavation
- 9 General shots of excavation
- 10 General shots of excavation
- 11 Trench One, after removal of 101, from the west.

-
- 12 Trench One, after removal of 101, from the south.
 - 13 Trench One, after removal of 101, from the south.
 - 14 Trench One, after removal of 101, from the north.
 - 15 Trench Two, after removal of 201, from the north.
 - 16 Trench Three, after removal of sod and 301, from the north.
 - 17 Trench Three, after removal of all of 301, from the east.
 - 18 Trench Three, after removal of all of 301, from the west.
 - 19 Trench Three, after removal of all of 301, from the west.
 - 20 Trench Three, after removal of all of 301, from the west.
 - 21 Trench Four, after removal of 401, from the north.
 - 22 General shots of coring.
 - 23 General shots of coring.
 - 24 General shots of coring.
 - 25 General shots of coring.

Film Three: Nikon F60: Fuji – 36 Superia 200 colour print film.

- 1 View of south facing section of drain overlaps with following.
- 2 View of south facing section of drain overlaps with following.
- 3 View of south facing section of drain overlaps with following.
- 4 View of south facing section of drain overlaps with following.
- 5 View of south facing section of drain overlaps with following.
- 6 View of south facing section of drain overlaps with following.
- 7 View of south facing section of drain overlaps with following.
- 8 View of south facing section of drain overlaps with following.
- 9 View of south facing section of drain overlaps with following.
- 10 View of south facing section of drain overlaps with following.
- 11 Trench Four, after excavation, from the south.
- 12 Trench Four, after excavation, from the south.
- 13 Trench Four, after excavation, from the west.
- 14 Trench Four, after excavation, from the west.
- 15 Trench Four, after excavation, from the east.
- 16 View of north facing section of drain overlaps with following.
- 17 View of north facing section of drain overlaps with following.
- 18 View of north facing section of drain overlaps with following.
- 19 View of north facing section of drain overlaps with following.
- 20 View of north facing section of drain overlaps with following.
- 21 View of north facing section of drain overlaps with following.
- 22 View of north facing section of drain overlaps with following.
- 23 View of north facing section of drain overlaps with following.
- 24 View of north facing section of drain overlaps with following.
- 25 View of north facing section of drain overlaps with following.
- 26 View of 305 and 310 on excavation
- 27 View of 305 and 310 on excavation
- 28 View of 305 and 310 on excavation
- 29 View of 305 and 310 on excavation
- 30 General shots of excavation of Trench Three
- 31 General shots of excavation of Trench Three
- 32 General shots of excavation of Trench Three
- 33 General shots of excavation of Trench Three
- 34 General shots of excavation of Trench Three
- 35 General shots of excavation of Trench Three
- 36 Location of posts, with shovels and spades as markers.
- 37 Shots of crew
- 38 Shots of crew

Digital Images:

-
- 1 General shot
 - 2 Axed wood found in drain
 - 3 General shot of drain
 - 4 General shot of burnt mound.
 - 5 Wood recovered previously from drain.
 - 6 Wood recovered previously from drain.
 - 7 View of lake area.
 - 8 View of unclassified mound to south-west, from south.
 - 9 View of unclassified mound to south-west, from south.
 - 10 View of unclassified mound to south-west, from south.
 - 11 View of lake area.
 - 12 General shot
 - 13 Cordoned Urn sherds
 - 14 Stone recovered from site.
 - 15 Cordoned Urn sherds
 - 16 Tanged arrowhead
 - 17 Tanged arrowhead
 - 18 Tanged arrowhead
 - 19 Tanged arrowhead
 - 20 Trench Two, on removal of 201, from South
 - 21 Trench One, on removal of 101, from South
 - 22 General shot
 - 23 Trench One, on removal of 101, from North.
 - 24 Trench Two, on removal of 201, from North.
 - 25 BA timbers disturbed previously.
 - 26 BA timbers disturbed previously.
 - 27 BA timbers disturbed previously.
 - 28 BA timbers disturbed previously.
 - 29 General shot
 - 30 General shot
 - 31 General shot
 - 32 General shot
 - 33 General shot
 - 34 Profile across drainage ditch
 - 35 Profile across drainage ditch
 - 36 Arrowhead in situ
 - 37 Arrowhead in situ
 - 38 Trench Four, possible furnace from south
 - 39 General shot
 - 40 General shot
 - 41 Location of monolith prior to removal
 - 42 General shot
 - 43 General shot
 - 44 General shot
 - 45 General shot
 - 46 General shot
 - 47 General shot
 - 48 Detail of toolmarks
 - 49 General shot
 - 50 General shot
 - 51 General shot
 - 52 Post 306
 - 53 General shot
 - 54 General shot
 - 55 Mock up of palisade using spades
 - 56 Mock up of palisade using spades
 - 57 General shot
 - 58 General shot

Appendix Four: Field Drawing Register

Drawing No.	Scale	Type	Description	Date and initials
1	1:20	Plan	Plan of Trench 1 with finds overlay following excavation of Context 101.	25/7/02; ST
2	1:20	Plan	Plan of Trench 2 with finds overlay following excavation of Context 201.	25/7/02; CL & LM
3	1:20	Plan	Plan of Trench 3 with finds overlay following excavation of Context 301.	26/7/02; CA
4	1:20	Plan	Plan of Trench 4 with finds overlay following excavation of Context 401.	30/7/02; AK & GT
5	1:20	Plan	Plan of Trench 4, incorporated into Plan 6 below.	1/8/02; AK & GT
6	1:20	Plan	Plan of excavated features, showing all trenches.	2/8/02; JO'N
7	1:10	Section	South-facing section of drainage ditch, joins with Plan 8.	2/8/02; JO'N
8	1:10	Section	South-facing section of drainage ditch, joins with Plan 7.	2/8/02; JO'N
9	1:10	Section	North-facing section of drainage ditch, joins with Plan 10.	2/8/02; JO'N
10	1:10	Section	North-facing section of drainage ditch, joins with Plan 9.	2/8/02; JO'N

Appendix Five: Small Finds Register

The co-ordinates for find locations are not given below, since the vast majority of finds are from topsoil or upcast, while others were recovered from the exposed sections through the drainage ditch (as indicated on figures 8 and 9)

Find no.	material	object	Trench	Context	Comments
1001	pottery	pottery	1	101	2 sherds
1002	flint	flake	1	101	
1003	flint	flake	1	101	
1004	pottery	pottery	1	104	number of sherds
1005	lithic	arrowhead	1	103	
1006	flint	flake	1	101	
1007	pottery	pottery	1	101	
1008	flint	flake	1	101	
1009	slag	unworked	1	101	3 pieces
1010	flint	flake	1	101	
1011	quartz	flake	1	101	
1012	flint	flake	1	101	
1013	quartz	flake	1	101	
1014	flint	modified flake	1	104	
1015	slag	unworked	1	101	
1016	slag	unworked	1	101	
1017	slag	unworked	1	101	
1018	slag	unworked	1	101	
1019	slag	unworked	1	101	
1020	slag	unworked	1	101	
1021	slag	unworked	1	101	
1022	slag	unworked	1	101	
1023	slag	unworked	1	101	
1024	slag	unworked	1	101	
1025	flint	flake	1	101	
1026	pottery	pottery	1	101	
1027	flint	flake	1	101	
1028	pottery	pottery	1	104	number of sherds
1029	pottery	pottery	1	101	From base of drain
1030	brick/pottery	fragments	1	101	
1031	pottery	pottery	1	101	
2001	pottery	pottery	2	201	

2002	pottery	pottery	2	201	2 sherds
2003	slag	unworked	2	201	
2004	flint	flake	2	201	
2006	miscellaneous		2	201	
2007	pottery	pottery	2	201	
3001	slag	unworked	3	301	
3002	flint	flake	3	301	
3003	slag	unworked	3	301	
3004	miscellaneous		3	301	
3005	wood		3	301	
3006	slag	unworked	3	301	
3007	slag	unworked	3	301	
3008	slag	unworked	3	301	
3009	wood		3	301	
3010	stone	rubbing stone	3	301	Dolerite
3011	slag	unworked	3	301	
3012	pottery	pottery	3	301	
4001	flint	flake	4	401	
4002	flint	concave scraper	4	417	
4003	flint	flake	4	401	
4004	flint	flake	4	401	
4005	flint	flake	4	401	
4006	flint	flake	4	401	
4007	slag	unworked	4	401	
4008	slag	unworked	4	401	
4009	slag	unworked	4	401	
4010	slag	unworked	4	401	
4011	slag	unworked	4	401	
4012	slag	unworked	4	401	
4013	slag	unworked	4	401	
4014	slag	unworked	4	401	
4015	pottery	unworked	4	401	
4016	pottery	pottery	4	401	
4017	flint	flake	4	412	
4018	pottery	pottery	4	401	
4019	slag	unworked	4	401	decorated sherds
4020	pottery	pottery	4	417	
4021	pottery	pottery	4	401	
4022	slag	unworked	4	401	

4023	slag	unworked	4	401	
4024	slag	unworked	4	401	
4025	slag	unworked	4	401	
4026	slag	unworked	4	401	
4027	metal?		4	401	
4028	slag	unworked	4	401	
4029	pottery	pottery	4	401	
4030	flint	flake	4	401	
4031	charcoal		4	401	
4032	pottery	pottery	4	401	
4033	flint	flake	4	401	
4034	flint	flake	4	401	
4035	pottery	pottery	4	401	
4036	slag	Unworked	4	401	
4037	miscellaneous		4	401	Modern finds
4038	glass		4	401	
4039	pottery	Pottery			from drain

Appendix Six: Samples Register

Sample No.	Source.	Description	No. of Bags	Volume (estimate)
305	Trench 3	Palisade Post	1	n/a
306	Drain	Palisade Post	1	n/a
307	See figure 8	Palisade Post	1	n/a
308	See figure 9	Palisade Post	1	n/a
309	Drain	Palisade Post	1	n/a
310	Trench 3	Palisade Post	1	n/a
Post	No context	Wood, structural, exposed in section.	1	n/a
Post	No context	Wood, structural, exposed in section.	1	n/a
Post	No context	Wood, structural, exposed in section.	1	n/a
5000	See figure 8	Wood, structural, exposed in section.	1	n/a
5001	See figure 8	Wood, structural, exposed in section.	1	n/a
5002	See figure 8	Wood, structural, exposed in section.	1	n/a
5003	See figure 8	Wood, structural, exposed in section.	1	n/a
5004	See figure 8	Wood, structural, exposed in section.	1	n/a
5005	See figure 8	Wood, structural, exposed in section.	1	n/a
5006	See figure 8	Wood, structural, exposed in section.	1	n/a
5007	See figure 8	Wood, structural, exposed in section.	1	n/a
5008	See figure 8	Wood, structural, exposed in section.	1	n/a
5009	See figure 8	Wood, structural, exposed in section.	1	n/a
5010	See figure 8	Wood, structural, exposed in section.	1	n/a
5011	See figure 8	Wood, structural, exposed in section.	1	n/a
5012	See figure 8	Wood, structural, exposed in section.	1	n/a
5013	See figure 8	Wood, structural, exposed in section.	1	n/a
5014	See figure 8	Wood, structural, exposed in section.	1	n/a
5015	See figure 8	Wood, structural, exposed in section.	1	n/a
5016	See figure 8	Wood, structural, exposed in section.	1	n/a
5017	See figure 8	Wood, structural, exposed in section.	1	n/a
5018	See figure 8	Wood, structural, exposed in section.	1	n/a
5019	See figure 8	Wood, structural, exposed in section.	1	n/a
5020	See figure 8	Wood, structural, exposed in section.	1	n/a
5021	See figure 8	Wood, structural, exposed in section.	1	n/a
6000	LDY14A:025	Charcoal eroding from exposed section face.	1	3 litres
6001	204	Sample retrieved from Trench 2 during excavation.	1	3 litres

6002	304	Sample retrieved from section.	1	3 litres
6003	407	Sample retrieved from section.	1	2 litres
6004	408	Sample retrieved from section.	1	2 litre
Core 1	See figure 3	Core retrieved using Russian corer.	various	4 m deep parallel core.
Core 2	See figure 3	Core retrieved using Russian corer.	Various	9 m deep parallel core
Monolith	See figure 9	Monolith tin, 1 m depth, retrieved from section.	1	80 litres